

Crafoord Astronomy Symposium Lecture

April 26, 2022

1

Presenter

Boon Chye Low

High Altitude Observatory

National Center for Atmospheric Research*

Boulder, Colorado, USA



*The National Center for Atmospheric Research
is sponsored by the National Science Foundation, USA

Spontaneous Current Sheets in Solar and Stellar Coronae

Eugene N. Parker

Crafoord Laureate 2020

S. Chandrasekhar Distinguished Service Professor Emeritus

University of Chicago

Chicago, Illinois, USA



The near-perfect electrically-conducting solar corona

3

Lundquist number: \mathcal{L}_η in a fluid flow of characteristic speed v_0 , length scale L , and resistivity η

$$\tau_v = \frac{L}{v_0}$$

$$v_\eta = \frac{\eta}{L}, \quad \tau_\eta = \frac{L}{v_\eta} = \frac{L^2}{\eta}$$

↑ Resistive diffusion speed

; “near-perfect conductivity” $\Leftrightarrow \eta \neq 0$, negligible under

$$\mathcal{L}_\eta = \frac{\tau_v}{\tau_\eta} = \frac{v_0 L}{\eta} \gg 1$$

The Fundamental Magnetostatic Theorem of Parker (1972):

- Under coronal condition $\mathcal{L}_\eta \gg 1$, 3D magnetic fields attain quasi-static equilibrium by embedding unlimitedly thin current sheets created **inevitably** by the actions of the Lorentz force.
- Each sheet dissipates by “resistive magnetic reconnection” via a local breakdown of the condition $\mathcal{L}_\eta \gg 1$ as sheet width $L_{sheet} \rightarrow 0$. The dissipation restores the local condition $\mathcal{L}_\eta \gg 1$, and current-sheets form **afresh**.
- Thus, the quasi-steady corona is in an endless **non-equilibrium**, maintaining large-scale force-balance and heated on the small scales by ubiquitous, intermittent, resistive dissipation of current sheets..
- Coronal magnetic fields provide the energy for heating, **replenished** by the Poynting flux from the slow-moving, turbulent heavy fluid below the coronal base.

A pretty view of the million-degree hot, X-ray emitting, fully-ionized solar corona:

- Near-perfect conductivity is as much **a consequence** of as it is **the reason** for the corona’s high temperature and fully-ionized state.

Focus of Lecture

- The elements of the Magnetostatic Theorem, discovered and developed in
Topological Dissipation and the Small-Scale Fields in Turbulent Gases
EN Parker, Astrophysical Journal, v. 174, p. 499, 1972
Spontaneous Current Sheets in Magnetic Fields
EN Parker, Oxford University Press, 1994
Topological Complexity and Tangential Discontinuity in Magnetic Fields.
Å. M. Janse, B. C. Low, E. N. Parker, Journal of Physics of Plasmas v. 17, id 092901, 2010
- Lecture will follow Gene's concept-transforming analysis that led to his theoretical discovery of the magnetically heated corona as a universal phenomenon.

The million-degree hot, magnetically-dominated, solar corona

July 3, 2020

$$R_{\odot} = 7 \cdot 10^5 \text{ km}$$

ubiquitous, intermittent, small-scale, heating

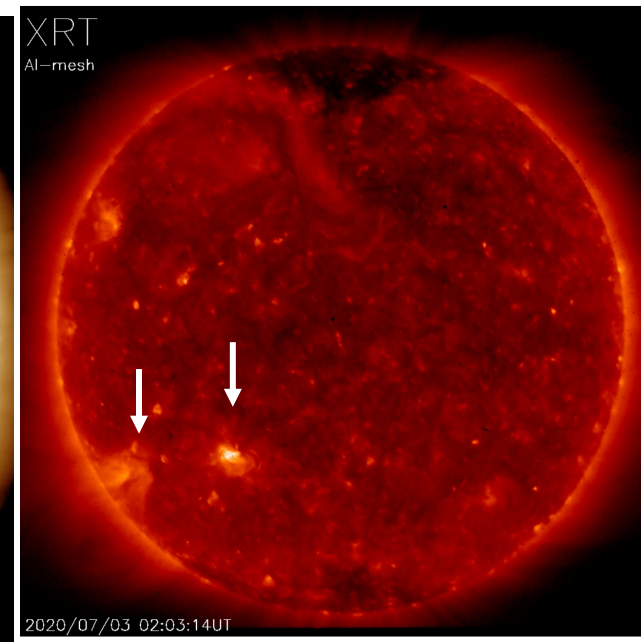
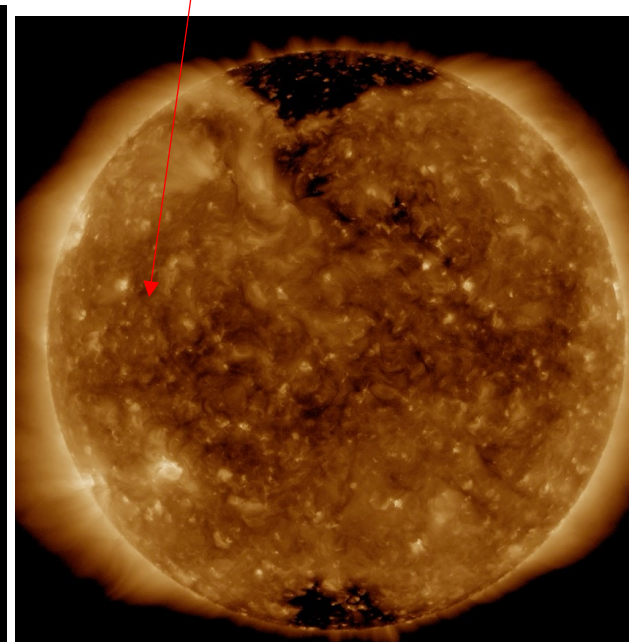
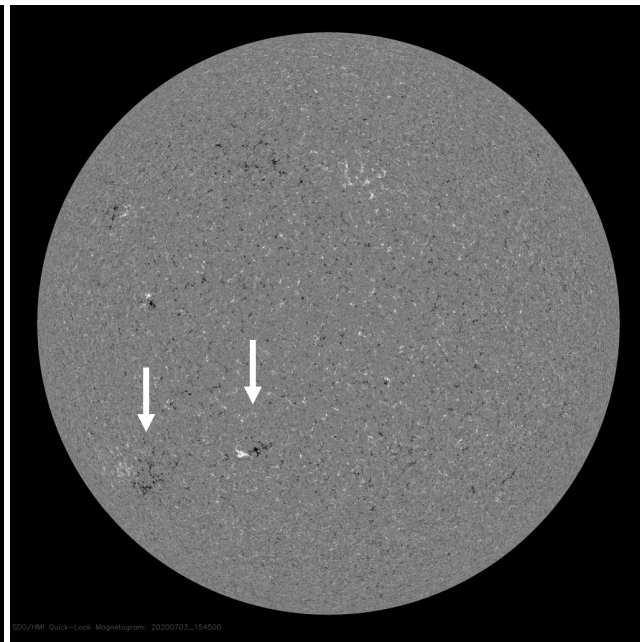
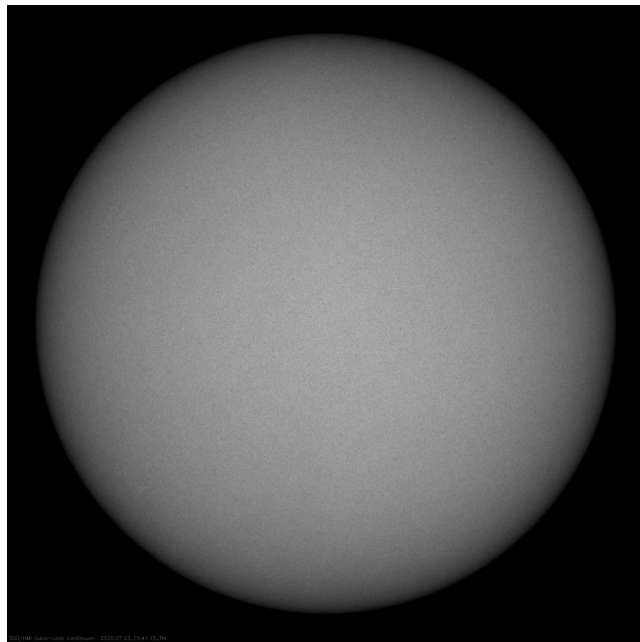

Temp $\sim 6 \cdot 10^3 \text{ K}$, $L_{\odot} \approx 4 \times 10^{33} \text{ erg/s}$
 $v_0 \sim 0.5 \text{ km/s}$, $L \sim 150 \text{ km}$
 White Light, NASA SDO-HMI
 July 3, 2020

LoS magnetic field $\sim 10 - 100 \text{ Gauss}$
 NASA SDO-HMI
 July 3, 2020

Temp $\sim 1.6 \cdot 10^6 \text{ K}$, $H_c \approx 10^{28-29} \text{ erg/s}$
 $v_0 \sim 500 \text{ km/s}$, $L \sim 10^4 \text{ km}$
 EUV 193 Å, NASA SDO-AIA
 July 2, 2020

Temp $\sim 3 \cdot 10^6 \text{ K}$
 X-ray, JASA Hinode XRT
 July 3, 2020

The white-light corona, known to humankind since prehistorical time - three-part helmet-streamer belts, Coronal Mass Ejections & the solar wind

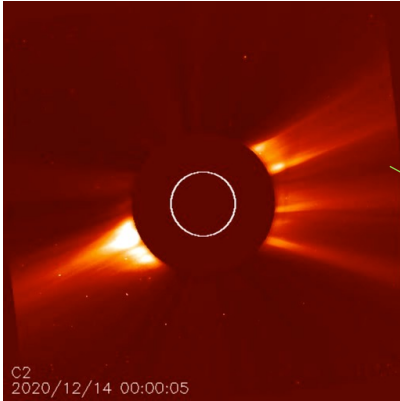

Coronal Mass Ejection during total eclipse Dec 14, 2020
NASA/ESA SOHO/LASCO, C2 Coronagraph
Occulting disk ~ 2 times solar radii

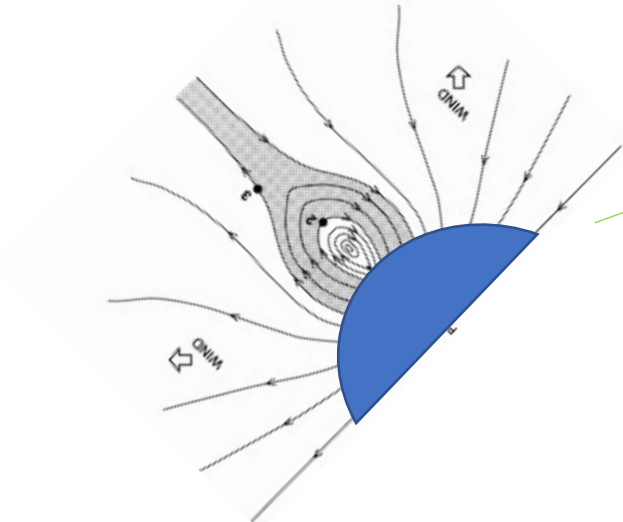
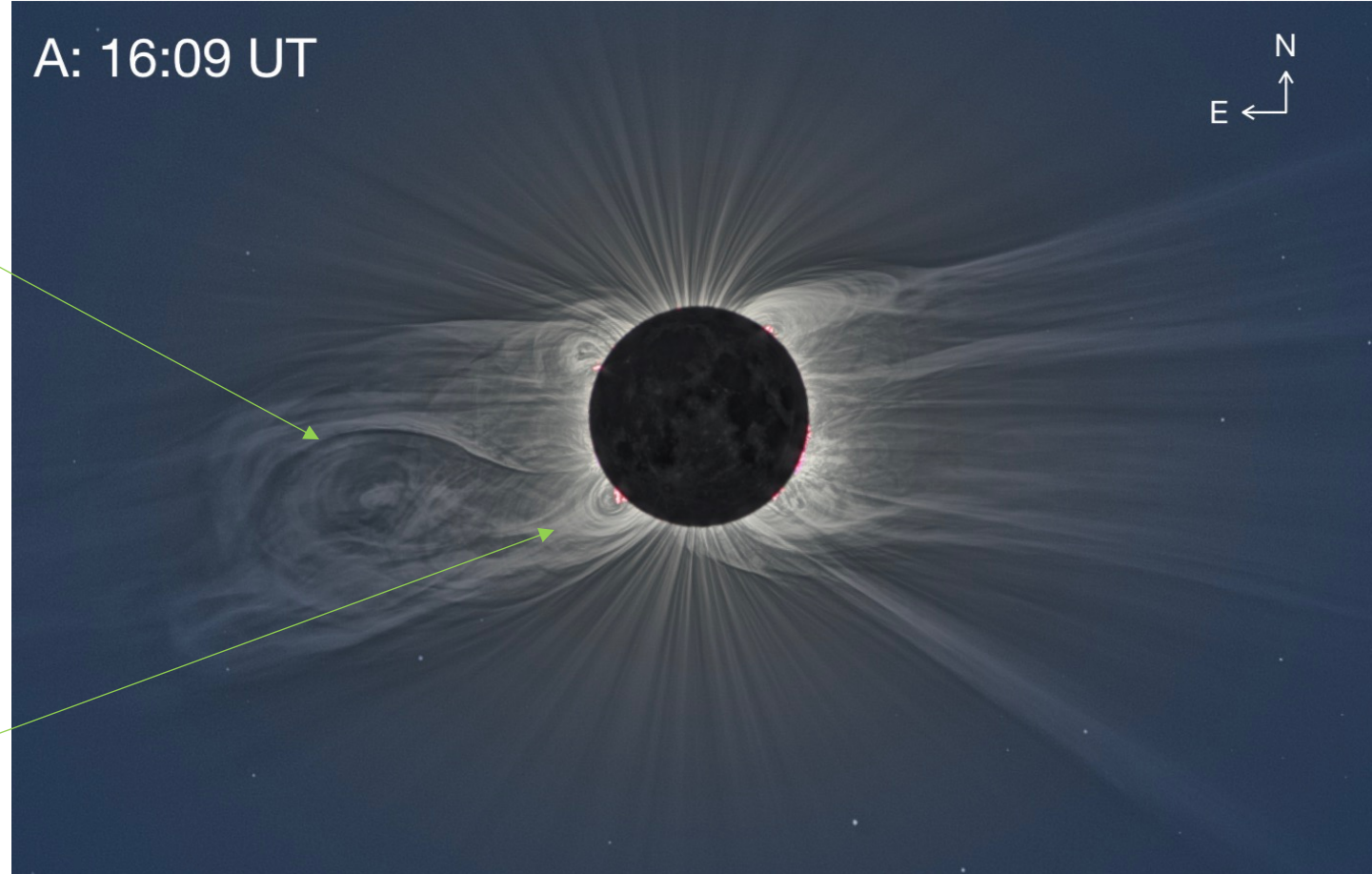

Total eclipse Dec 14, 2020,
Argentina, composite frames,
Boe et al. 2021, *ApJ*, **914**, id.L39.

Non-relativistic $|v| \ll c$, Galilean invariant, single-fluid MHD equations

7

Newton:	$\rho \left[\frac{\partial}{\partial t} + (\mathbf{v} \cdot \nabla) \right] \mathbf{v} = \frac{1}{4\pi} [\nabla \times \mathbf{B}] \times \mathbf{B} - \nabla p - \rho \nabla \psi + \nu_1 \nabla^2 \mathbf{v} + \nu_2 \nabla [\nabla \cdot \mathbf{v}]$	
Mass:	$\frac{\partial}{\partial t} \rho + \nabla \cdot (\rho \mathbf{v}) = 0 ;$	$\rho = n_p m_p$
Entropy:	$\left[\frac{\partial}{\partial t} + (\mathbf{v} \cdot \nabla) \right] (p \rho^{-5/3}) = S ;$	$p = 2n_p k_B T$
Induction:	$\frac{\partial}{\partial t} \mathbf{B} = \nabla \times [\mathbf{v} \times \mathbf{B}] + \eta \nabla^2 \mathbf{B} ;$	$\eta = \frac{c^2}{4\pi\sigma}$
Derived MHD variables:	$\mathbf{J} = \frac{c}{4\pi} \nabla \times \mathbf{B}, \quad \mathbf{E} = \frac{1}{c} [\eta \nabla \times \mathbf{B} - \mathbf{v} \times \mathbf{B}],$	$T = \frac{p m_p}{2\rho k_B}$

Lorentz force = $\frac{1}{c} \mathbf{J} \times \mathbf{B} = \frac{1}{4\pi} [\nabla \times \mathbf{B}] \times \mathbf{B} \sim \mathcal{O}(1)$
Electrostatic force = $\frac{1}{4\pi} [\nabla \cdot \mathbf{E}] \mathbf{E} \sim \mathcal{O}\left(\frac{v^2}{c^2}\right)$
NOTEWORTHY: speed of light c must not appear in the Newtonian MHD equations!

In the magnetically dominated corona:

$$\beta = \frac{8\pi p}{B^2} \ll 1, \quad \frac{\eta}{v_0 L} = \frac{1}{\mathcal{L}_\eta} \ll 1$$

Set $\beta = 0, \eta = 0$ for a magnetic field in a perfect fluid conductor of negligible pressure

Newton:

$$\rho \left[\frac{\partial}{\partial t} + (\mathbf{v} \cdot \nabla) \right] \mathbf{v} = \frac{1}{4\pi} [\nabla \times \mathbf{B}] \times \mathbf{B} + \nu_1 \nabla^2 \mathbf{v} + \nu_2 \nabla [\nabla \cdot \mathbf{v}]$$

Mass:

$$\frac{\partial}{\partial t} \rho + \nabla \cdot (\rho \mathbf{v}) = 0$$

Eulerian description

Induction:

$$\frac{\partial}{\partial t} \mathbf{B} = \nabla \times [\mathbf{v} \times \mathbf{B}]$$

Gene's sketch of a magnetic flux-surface swept out by a continuum of field lines.

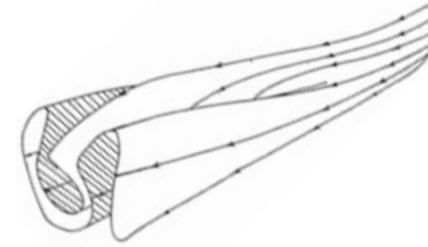

The frozen-in condition:

Description of \mathbf{B} in terms of the **invariant** flux \mathcal{F} across each fluid-surface Σ deforming in the flow \mathbf{v} :

Lagrangian description

$$\frac{d}{dt} \mathcal{F} \equiv \frac{d}{dt} \int_{\Sigma} \mathbf{B} \cdot d\Sigma = 0.$$

- * Magnetic flux-surfaces Σ on which $\mathbf{B} \cdot d\Sigma \equiv 0$ move as fluid-surfaces.
- * **Permanent partition** of the fluid by the flux-surfaces of a given \mathbf{B} into macroscopic, magnetic sub-volumes each containing its **invariant** same fluid..

Field-discontinuities/current-sheets :

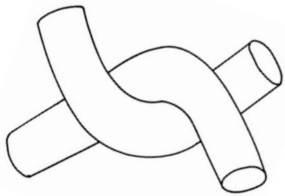

Two tangled magnetic flux tubes pushing into direct contact.

- * Two flux tubes in unrestricted 3D motions can force their way into direct tangential contact, producing **tangential discontinuities** in \mathbf{B} across flux surfaces, related by Ampere's Law to finite, **discrete currents** flowing in sheets of zero thickness on the flux surfaces.
- * **Zero-thickness current sheets are the hallmark of perfect conductivity with $\eta = 0$ rigorously.**
- * In the $\eta \neq 0$ corona, current sheet thinning also occurs under $\mathcal{L}_\eta \gg 1$ until resistive dissipation intervenes via local breakdowns of the $\mathcal{L}_\eta \gg 1$ condition.

The viscous relaxation of a boundary-anchored field to equilibrium (Parker 1972)

$$\rho \left[\frac{\partial}{\partial t} + (\mathbf{v} \cdot \nabla) \right] \mathbf{v} = \frac{1}{4\pi} [\nabla \times \mathbf{B}] \times \mathbf{B} + \nu_1 \nabla^2 \mathbf{v} + \nu_2 \nabla [\nabla \cdot \mathbf{v}],$$

$$\frac{\partial}{\partial t} \rho + \nabla \cdot (\rho \mathbf{v}) = 0,$$

$$\frac{\partial}{\partial t} \mathbf{B} = \nabla \times [\mathbf{v} \times \mathbf{B}], \text{ subject to}$$



Coronal "bipolar" magnetic field

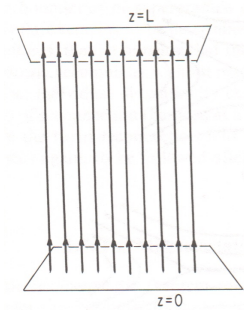

$\mathbf{B}_0 = B_0 \hat{z}$

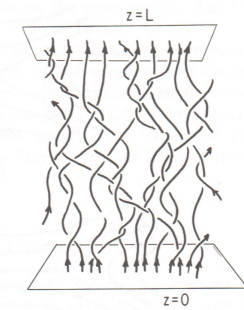

$\mathbf{B}(x, y, z, 0) = \mathbf{B}_0 + \mathbf{b}_{initial}(x, y, z)$
All field lines anchored at $z = 0, L$.

Initial conditions: $t = 0, \rho = \rho_0, \mathbf{v} = 0, \mathbf{B}(x, y, z, 0) = B_0 \hat{z} + \mathbf{b}_{initial}(x, y, z),$

Rigid boundary conditions: $b_z = 0, \mathbf{v} = 0$ at $z = 0, L; |\mathbf{b}|^2 \rightarrow 0, |\mathbf{v}|^2 \rightarrow 0$ at $(x^2 + y^2)^{1/2} \rightarrow \infty.$

Monotonic decay of the total energy \mathcal{E} :

$$\frac{d}{dt} \mathcal{E} \equiv \frac{d}{dt} \int_{0 < z < L} \left[\frac{1}{2} \rho |\mathbf{v}|^2 + \frac{1}{8\pi} |\mathbf{b}|^2 \right] dx dy dz = - \int_{0 < z < L} [\nu_1 |\nabla \times \mathbf{v}|^2 + \nu_2 |\nabla \cdot \mathbf{v}|^2] dx dy dz \Rightarrow \lim_{t \rightarrow \infty} |\mathbf{v}|^2 = 0,$$

i.e., the Lorentz force drives an energy-minimizing evolution to a terminal force-free field denoted by $\mathbf{B}_\infty(x, y, z) = B_0 \hat{z} + \mathbf{b}_\infty(x, y, z)$ satisfying

$$[\nabla \times \mathbf{B}_\infty] \times \mathbf{B}_\infty = 0, \quad \nabla \cdot \mathbf{B}_\infty = 0,$$

subject to boundary conditions: $b_{\infty, z} = 0$ at $z = 0, L$, and, $|\mathbf{b}_\infty|^2 \rightarrow 0$ at $(x^2 + y^2)^{1/2} \rightarrow \infty.$ This static problem has an infinity of solutions among which the unique terminal field $\mathbf{B}_\infty(x, y, z)$ is identified by the initial-boundary problem to have evolved **continuously** from the initial field $\mathbf{B}(x, y, z, 0).$

Analyticity has been assumed but the frozen-in condition cautions that \mathbf{B}_∞ may be discontinuous and embedded with current sheets. **The Magnetostatic Theorem shows that, in fact, a discontinuous \mathbf{B}_∞ is the rule rather than the exception.**

Three-flux interaction under $\infty > \mathcal{L}_\eta = \frac{v_0 L}{\eta} \gg 1$ leading to resistive magnetic reconnection

2D Cartesian process

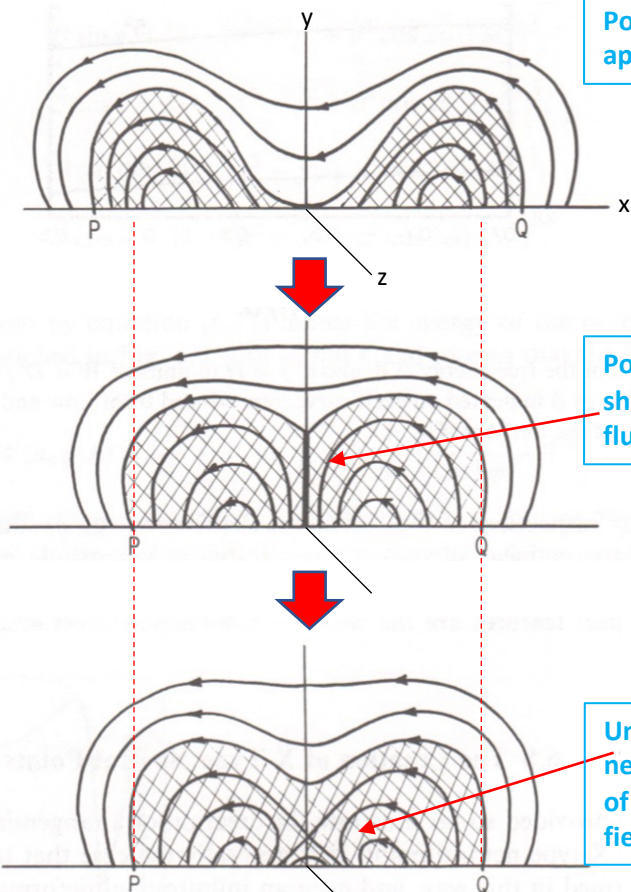

Potential field, two shaded fluxes kept apart by third flux, no neutral point.

Potential field with vertical current sheet, $0 < y < y_0$, by expulsion of third flux from between shaded fluxes.

Unique potential field with X-type neutral point after resistive dissipation of current sheet and reconnection of field.

The current density of a 2D field in a Cartesian plane is always perpendicular to the field,
 $[\nabla \times \mathbf{B}] \times \mathbf{B} = 0 \Rightarrow \nabla \times \mathbf{B} = \delta(x) I(y) \hat{\mathbf{z}}$ with $I(y) \neq 0$ in $0 < y < y_0$

3D processes, no ignorable coordinate

Any flux-surface is a candidate for formation of magnetic discontinuity or current sheet

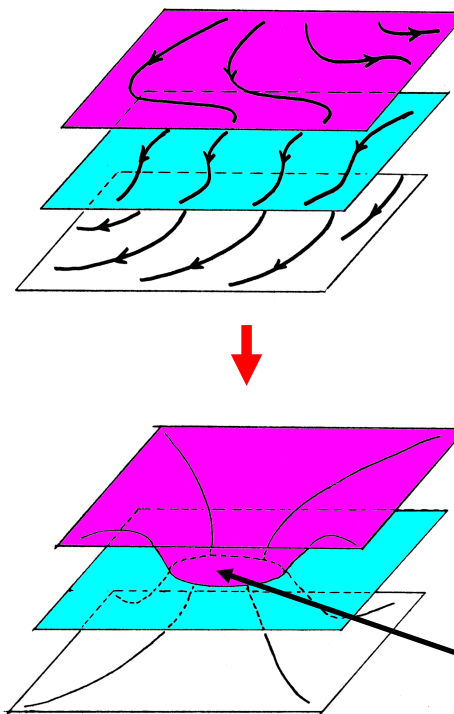

Three representative magnetic flux-surfaces

Maroon, white flux-surfaces make contact thru hole opened up in blue flux-surface

Flux-surfaces in field reconnection

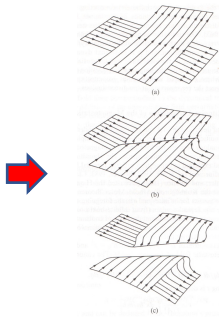

Pausing to ask “What is field topology?”

Definition of topology. Magnetic flux-tubes as geometric objects have topological properties that are invariant under **continuous** deformation, no cutting nor re-gluing allowed. **Fortunately**, to proceed we can circumnavigate the mathematics of topological invariance, e.g., how to quantify the mutual linkages of tangled flux tubes anchored to $z=0, L$. It suffices today to use the concept of topological equivalence. **Two geometric objects are topologically equivalent if one is continuously deformable into the other.**

The Two-Plate magnetic field is a physical entity identified by its invariant topology \mathcal{T} .

The initial field $\mathbf{B}(x, y, z, 0)$ is more than just a prescribed initial condition, for it identifies a unique field of an invariant topology \mathcal{T} , that assumes different physical states generated by the continuous deformations of it. This understanding clarifies the meaning of the initial-boundary value problem. The Lorentz-force drives each given initial field $\mathbf{B}(x, y, z, 0)$ of a fixed \mathcal{T} along an energy-minimizing path in the space $\mathcal{W}_{\mathcal{T}}$ of continuous **topologically-equivalent fields** to a unique force-free end-state \mathbf{B}_{∞} . The non-trivial question thus arises whether \mathbf{B}_{∞} is necessarily continuous and resides in $\mathcal{W}_{\mathcal{T}}$. We have arrived at the threshold of the Magnetostatic Theorem.

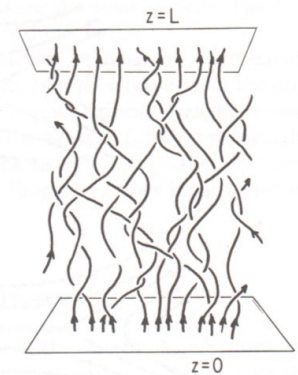
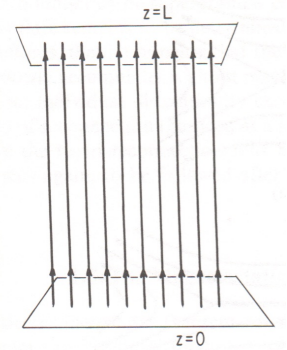

Anisotropic Lorentz Force:

$$[\nabla \times \mathbf{B}] \times \mathbf{B} \equiv [\mathbf{B} \cdot \nabla] \mathbf{B} - \nabla \left[\frac{1}{2} B^2 \right]$$

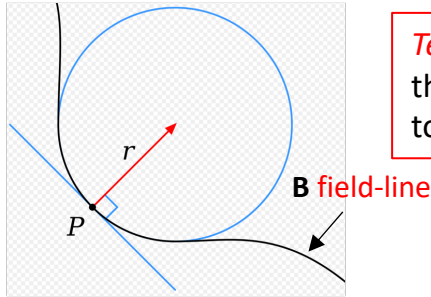

Credit: Wikipedia

Tension force at each point P on a field-line lying in the so-called osculating **circle of curvature** that touches both the field line and its **tangent** at P.

Pressure force, everywhere directed normal to the level surfaces of constant, isotropic magnetic pressure B^2 .

*** Under the frozen-in condition, the two components may not be geometrically compatible for mutual cancelation in a 3D force-free field if we **extraneously** demand for the field to be analytical.**

Analytical force-free fields:

Given the force-free field equations

$$[\nabla \times \mathbf{B}] \times \mathbf{B} \equiv [\mathbf{B} \cdot \nabla] \mathbf{B} - \nabla \left[\frac{1}{2} B^2 \right] = 0, \quad \nabla \cdot \mathbf{B} = 0,$$

analyticity implies $\nabla \times \left\{ \nabla \left[\frac{1}{2} B^2 \right] \right\} = 0$, from vector calculus, essential for the magnetic pressure to be single-valued in space. The **necessary** condition then follows,

$$\nabla \times \{ [\mathbf{B} \cdot \nabla] \mathbf{B} \} = 0,$$

under which a force-free field of a given topology \mathcal{T} may be constructed as an analytical solution of

$$\nabla \times \mathbf{B} = \alpha \mathbf{B}, \quad \mathbf{B} \cdot \nabla \alpha = 0,$$

using Ampere's Law to express the current density being parallel to the field. The scalar function α carries the solenoidal condition and field topology. This is the starting point of the Magnetostatic Theorem.

The force-free field as a series expansion about the uniform field. Consider the analytical force-free field

$$\mathbf{B}_\infty = \mathbf{B}_0 + \mathbf{b}_\infty \equiv B_0 \hat{\mathbf{z}} + \sum_{n=1}^{\infty} \mathbf{b}_n \epsilon^n, \quad \epsilon \ll 1$$

$$(\nabla \times \mathbf{B}_\infty) \times \mathbf{B}_\infty \equiv [\mathbf{B}_\infty \cdot \nabla] \mathbf{B}_\infty - \nabla \left[\frac{1}{2} B_\infty^2 \right] = 0, \quad \nabla \cdot \mathbf{B}_\infty = 0,$$

$$b_{n,z} = 0 \text{ at } z = 0, L, \text{ for all } n, \text{ so that } B_{\infty,z} = B_0 \text{ at } z = 0, L.$$

The boundary layers at $z = 0, L$, thickness of the order of ϵ , may be ignored in the limit of $\epsilon \rightarrow 0$ by virtue of **analyticity**. Then, imposing the necessary condition on \mathbf{B}_∞ being analytical gives the rigorous result

$$\nabla \times [(\mathbf{B}_\infty \cdot \nabla) \mathbf{B}_\infty] = 0 \implies \frac{\partial}{\partial z} \mathbf{b}_n = 0 \text{ to all order } n \implies \frac{\partial}{\partial z} \mathbf{B}_\infty = 0,$$

severely restricting **all** ϵ -series force-free fields \mathbf{B}_∞ . Therefore, all but the simplest prescribed $\mathbf{B}(x, y, z, 0)$

must evolve into a minimum-energy, force-free terminal field \mathbf{B}_∞ **not** everywhere continuous and embedding infinitesimally thin current-sheets on pieces of flux surfaces \mathcal{S}_i across which \mathbf{B}_∞ is tangentially discontinuous. The terminal field \mathbf{B}_∞ is approached by the Lorentz force vanishing in the continuous part of \mathbf{B}_∞ as well as on the current sheets on \mathcal{S}_i , the latter in force-balance by having the magnetic pressure $|\mathbf{B}_\infty|^2$ continuous across \mathcal{S}_i . The force-free equations for \mathbf{B}_∞ have the complex form of Ampere's Law:

$$\nabla \times \mathbf{B}_\infty = \alpha \mathbf{B}_\infty + \sum_i \mathcal{C}_i[\mathcal{S}_i], \quad \langle |\mathbf{B}_\infty|^2 \rangle_{\mathcal{S}_i} = 0, \quad \mathbf{B}_\infty \cdot \nabla \alpha = 0,$$

where $\mathcal{C}_i[\mathcal{S}_i]$ is the discrete currents on \mathcal{S}_i and the vanishing angular bracket describes the continuity of $|\mathbf{B}_\infty|^2$ across \mathcal{S}_i .

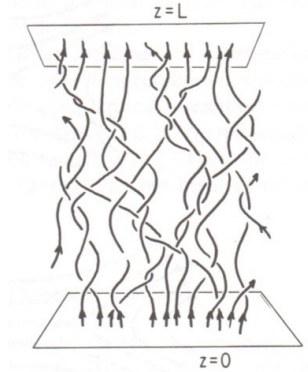

$\mathbf{B}_{initial} = \mathbf{B}_0 + \mathbf{b}_{initial}$

The coronal implications of the Magnetostatic Theorem

14

- **The two complementary sub-spaces of field topologies.** Consider the mathematical space of the **topologies \mathcal{T} of the continuous anchored fields realizable** in the Two-Plate problem,

$$\mathbb{T}_{all}[\mathcal{T}] = \mathbb{T}_{analytic}[\mathcal{T}] \cup \mathbb{T}_{cs}[\mathcal{T}],$$

the two sub-spaces distinguished by whether the terminal field \mathbf{B}_∞ of topology \mathcal{T} is analytical or discontinuous with embedded, force-balanced current sheets. The extreme condition $\frac{\partial}{\partial z} \mathbf{B}_\infty = 0$ on the terminal field for $\mathcal{T} \in \mathbb{T}_{analytic}[\mathcal{T}]$, implies that $\mathbb{T}_{analytic}[\mathcal{T}]$ is “**by far of a smaller size**” than $\mathbb{T}_{cs}[\mathcal{T}]$ in a probabilistic sense. Which is to say, if a topology $\mathcal{T} \in \mathbb{T}_{all}[\mathcal{T}]$ is picked randomly, the probability is zero of having picked a $\mathcal{T} \in \mathbb{T}_{analytic}[\mathcal{T}]$.

- **Origin of the corona in its state interminable restless reconnection.** When a current sheet forms under near-perfect conductivity $\mathcal{L}_\eta \gg 1$ in a coronal field with $\mathcal{T} \in \mathbb{T}_{cs}[\mathcal{T}]$, which then dissipates via a local breakdown of the condition $\mathcal{L}_\eta \gg 1$, the field topology changes from \mathcal{T} to \mathcal{T}' with zero probability for $\mathcal{T}' \in \mathbb{T}_{analytic}[\mathcal{T}]$. So, the reconnected field forms fresh current sheets, and the process repeats endlessly with the field topology changing randomly within $\mathbb{T}_{cs}[\mathcal{T}]$. Thus, the coronal field is quasi-static on the large scale but is persistently pervaded with ubiquitous, intermittent, small-scale reconnection events. The finite free magnetic energy of the rigidly anchored field must decrease in time, which only means that the **inevitable** current sheets form with diminishing current intensities. The coronal base is not rigid as assumed for simplicity in the Two-Plate problem. The Poynting flux from the slow, turbulent, heavy fluids below the coronal base readily replenishes the free magnetic energy and sustains the persistent heating of the corona.

The generality of the Magnetostatic Theorem

- **Proof of generality.** It is formidable to construct force-free fields with force-balanced current-sheets as unknown free-surfaces to be determined self-consistently. The generality of the Magnetostatic Theorem has been established by the wealth of illustrative examples in Gene's monograph. These examples were helped by the realization that the analytical force-free fields are distributed sparsely among the dense population of discontinuous force-free fields. That is to say, an analytical force-free field generally lies "isolated" in a neighborhood of discontinuous force-free fields. With this hindsight of the Magnetostatic Theorem, nudging an analytical force-free field from its endowed compliance with $\frac{\partial}{\partial z} \mathbf{B}_\infty = 0$ can be shown to lead to irrepressible current sheets.

The Lecture now concludes with an interesting example of current sheet formation.

The non-force-free Parker modification of the cylindrical Lundquist force-free field

Cylindrical field:
$$\begin{cases} \mathbf{B} = B_\phi(R)\hat{\phi} + B_z(R)\hat{z} \\ [\nabla \times \mathbf{B}] \times \mathbf{B} = -\left\{ \frac{1}{2} \frac{d}{dR} [B_z^2 + B_\phi^2] + \frac{B_\phi^2}{R} \right\} \hat{R} \end{cases}$$

Lundquist force-free field:
$$\begin{cases} \mathbf{B} = J_1(R)\hat{\phi} + J_0(R)\hat{z} \\ [\nabla \times \mathbf{B}] \times \mathbf{B} = 0 \Leftrightarrow \nabla \times \mathbf{B} = \alpha \mathbf{B}, \alpha = 1 \end{cases}$$

Parker non-force-free field:
$$\begin{cases} \mathbf{B} = J_1(R)\hat{\phi} + B_0\hat{z} \\ [\nabla \times \mathbf{B}] \times \mathbf{B} = -\left\{ \frac{1}{2} \frac{d}{dR} [B_\phi^2] + \frac{B_\phi^2}{R} \right\} \hat{R} \\ = -J_0(R)J_1(R)\hat{R} \end{cases}$$

... to be treated as the initial field $\mathbf{B}(x, y, z, 0)$ in the initial-boundary value problem.

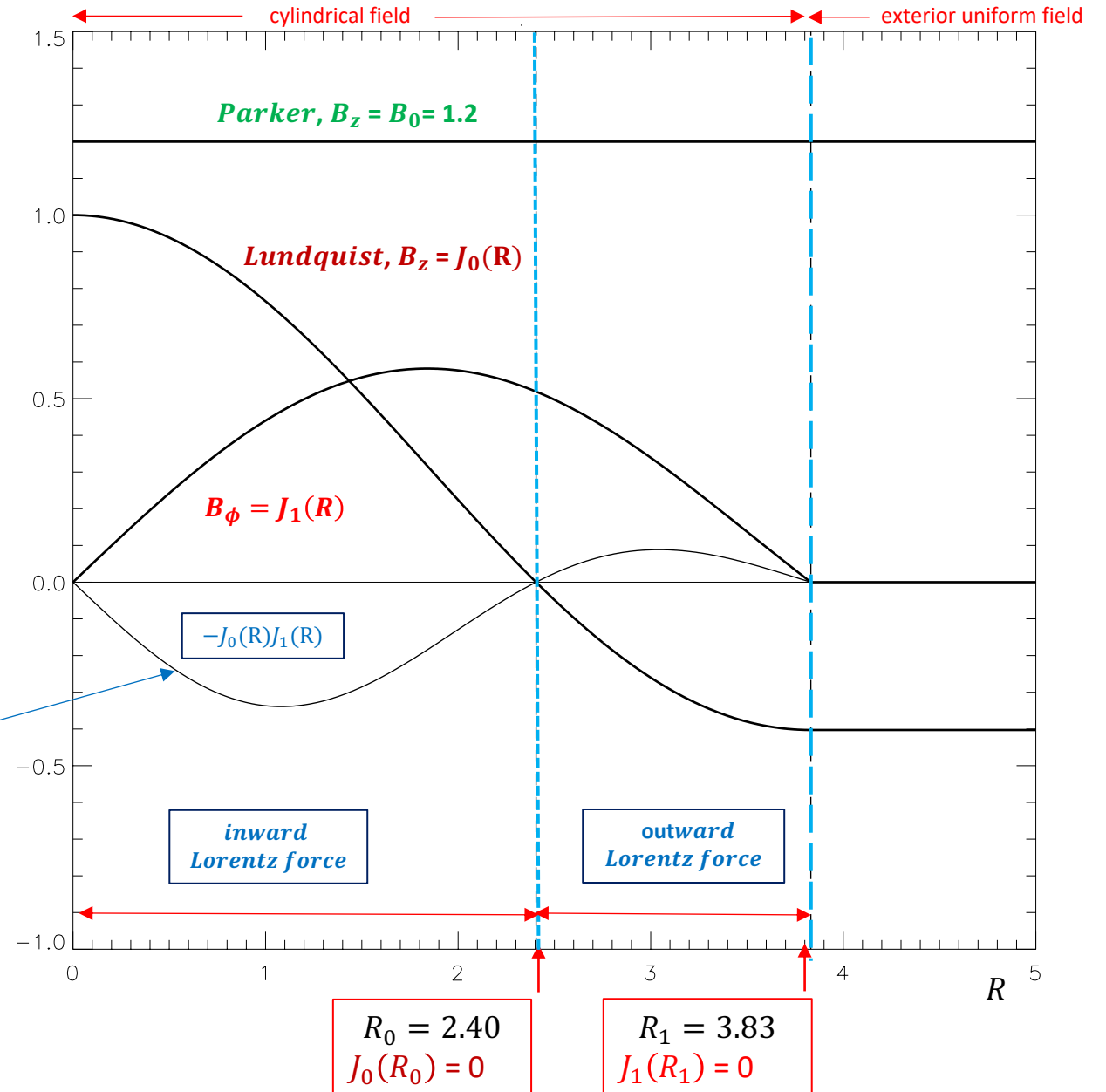

Internal formation of current sheet via re-distributions of magnetic twist in the Parker Field

Current sheet most intense. Something for some other time!

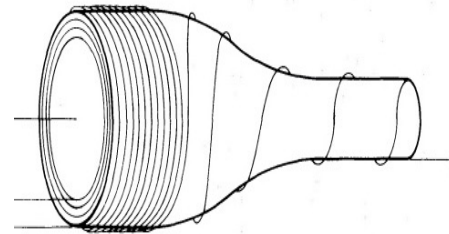
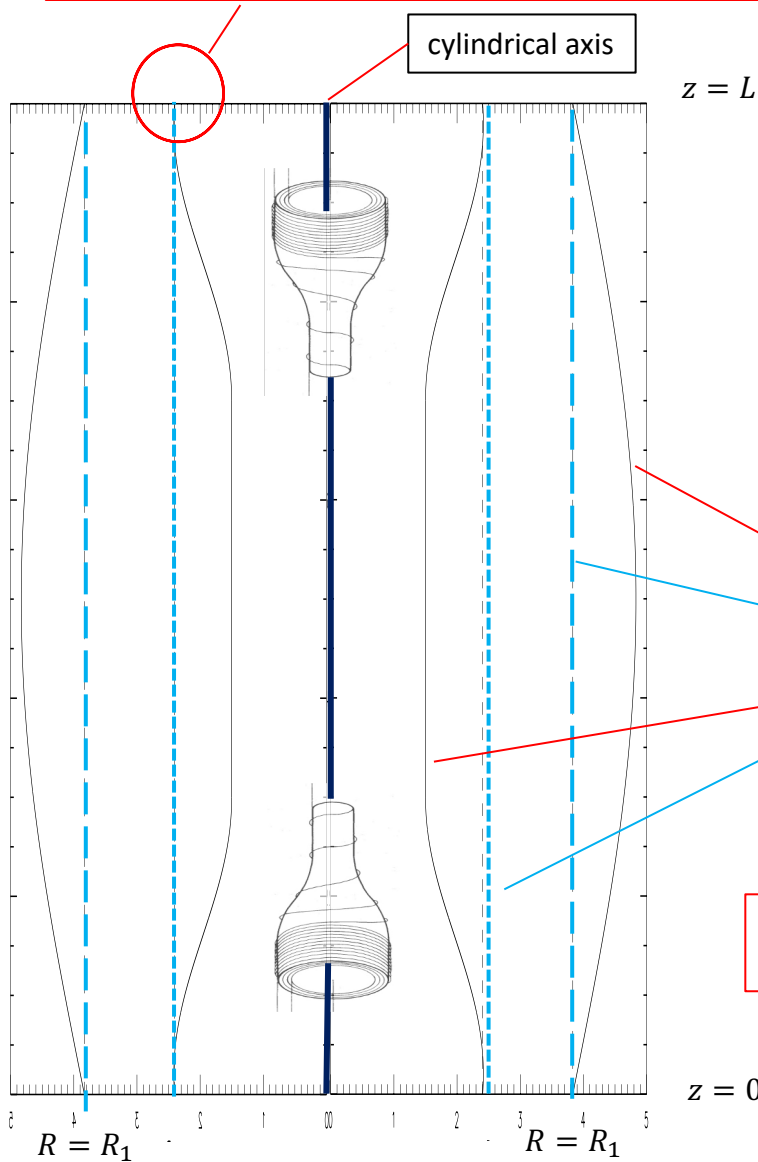

The dynamical properties of twisted ropes of magnetic field ...
EN Parker, ApJ 191,245,1974.

Outward-bulged, boundary of twisted field

Originally-vertical boundary of twisted field

Inward-compression of boundary of the pinched axial flux

Originally-vertical boundary of the self-compressing axial flux

How about breaking the up-down symmetry?
Something for some other time!

Spontaneous Current Sheets in Magnetic Fields

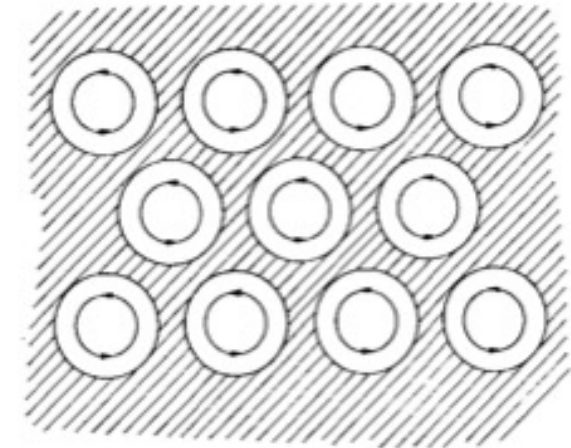

(a)

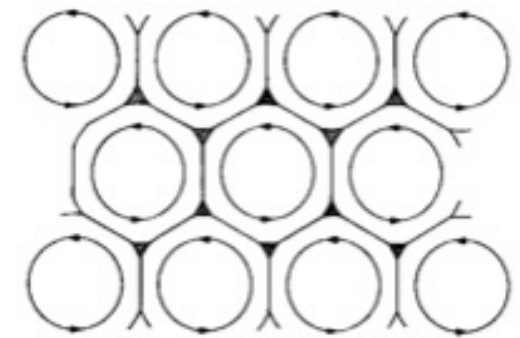

(b)

A concluding quote on the atmospheric nature of the corona ...

“....any but the simplest field topologies had no equilibrium, because the field is in a state of nonequilibrium, i.e., rapid reconnection, if it has any but the simplest topologies.”

E. N. Parker

Spontaneous Current Sheets in Magnetic Fields, page 306

Oxford University Press, 1994

A concluding thought, Gene's discovery is as much about a fundamental MHD property and process as it is about the nature of the magnetic heating of the corona as a universal astrophysical phenomenon. Stars and galaxies have X-ray emitting million-degree coronae that must also be expected to be expanding into stellar and galactic winds as the compelling way of thinking about the universality and consistency of what physics can know.

End

This presentation of 20 slides is made with no prejudice to the copyrights to it, if any, that may be held by the Estate of Eugene Newman Parker, the Crafoord Foundation, and the University Corporation for Atmospheric Research, USA

Boon Chye Low, April 21, 2022